

Four row taper roller bearing inch series

d 889 - 1250mm-BT4B332720/HA4

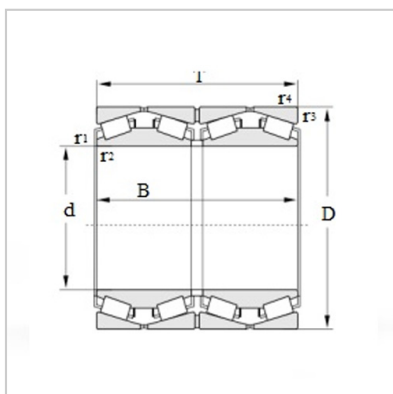

Reference code :

SKF :	BT4B332720/HA4
TIMKEN :	

Boundary Dimensions :

d :	1004.634
D :	1308.100
T :	730.250
B :	812.800
r1.2min :	12.7
r3.4min :	3.3

Basic Load Rating :

Cr :	24600
Cor :	76500

Calculation parameter :

e :	0.33
Y1 :	2.0
Y2 :	3.0
Y0 :	2.0

Mass :

kg :	3060
------	------

: