

Four row taper roller bearing inch series

d 889 - 1250mm-BT4B331373/HA4

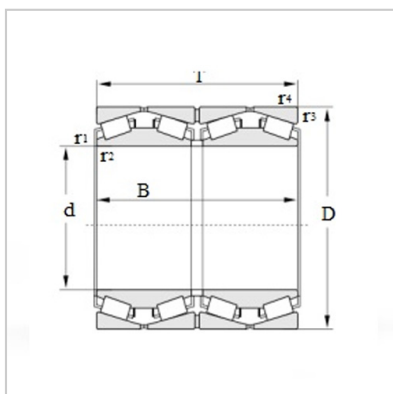

Reference code :

SKF :	BT4B331373/HA4
TIMKEN :	

Boundary Dimensions :

d :	1003.300
D :	1358.900
T :	800.100
B :	800.100
r1.2min :	4.8
r3.4min :	12.7

Basic Load Rating :

Cr :	27500
Cor :	81500

Calculation parameter :

e :	0.31
Y1 :	2.2
Y2 :	3.3
Y0 :	2.2

Mass :

kg :	3450
------	------

: